

I1 Polar Class Descriptions and Application

(August
2006)
(Rev.1
Jan
2007)
(Corr.1
Oct
2007)
(Rev.2
Apr
2016)

I1.1 Application

I1.1.1 The Unified Requirements for Polar Class ships apply to ships constructed of steel and intended for independent navigation in ice-infested polar waters.

I1.1.2 Ships that comply with the UR I2 and UR I3 can be considered for a Polar Class notation as listed in Table 1. The requirements of UR I2 and UR I3 are in addition to the open water requirements of the Classification Society. If the hull and machinery are constructed such as to comply with the requirements of different Polar Classes, then both the hull and machinery are to be assigned the lower of these classes in the Certificate of Classification. Compliance of the hull or machinery with the requirements of a higher Polar Class is also to be indicated in the Certificate of Classification or equivalent.

I1.1.3 Ships which are assigned a Polar Class notation and complying with the relevant requirements of UR I2 and UR I3 may be given the additional notation "Icebreaker". "Icebreaker" refers to any ship having an operational profile that includes escort or ice management functions, having powering and dimensions that allow it to undertake aggressive operations in ice-covered waters.

I1.1.4 For ships which are assigned a Polar Class notation, the hull form and propulsion power are to be such that the ship can operate independently and at continuous speed in a representative ice condition, as defined in Table 1 for the corresponding Polar Class. For ships and ship-shaped units which are intentionally not designed to operate independently in ice, such operational intent or limitations are to be explicitly stated in the Certificate of Classification or equivalent.

I1.1.5 For ships which are assigned a Polar Class notation PC 1 through PC 5, bows with vertical sides, and bulbous bows are generally to be avoided. Bow angles should in general be within the range specified in I2.3.1 (v).

Note:

1. UR I1 applies to ships contracted for construction on or after 1 July 2007.
2. Rev.1 of this UR is to be uniformly applied by IACS Societies on ships contracted for construction on and after 1 March 2008.
3. Rev.2 of this UR is to be uniformly implemented by IACS Societies on ships contracted for construction on and after 1 July 2017.
4. The "contracted for construction" date means the date on which the contract to build the vessel is signed between the prospective owner and the shipbuilder. For further details regarding the date of "contract for construction", refer to IACS Procedural Requirement (PR) No. 29.

I1 (cont)

I1.1.6 For ships which are assigned a Polar Class notation PC 6 and PC 7, and are designed with a bow with vertical sides or bulbous bows, operational limitations (restricted from intentional ramming) in design conditions are to be stated in the Certificate of Classification or equivalent.

I1.2 Polar Classes

I1.2.1 The Polar Class (PC) notations and descriptions are given in Table 1. It is the responsibility of the Owner to select an appropriate Polar Class. The descriptions in Table 1 are intended to guide owners, designers and administrations in selecting an appropriate Polar Class to match the requirements for the ship with its intended voyage or service.

I1.2.2 The Polar Class notation is used throughout the Unified Requirements for Polar Class ships to convey the differences between classes with respect to operational capability and strength.

Table 1 - Polar Class descriptions

Polar Class	Ice descriptions (based on WMO Sea Ice Nomenclature)
PC 1	Year-round operation in all polar waters
PC 2	Year-round operation in moderate multi-year ice conditions
PC 3	Year-round operation in second-year ice which may include multi-year ice inclusions.
PC 4	Year-round operation in thick first-year ice which may include old ice inclusions
PC 5	Year-round operation in medium first-year ice which may include old ice inclusions
PC 6	Summer/autumn operation in medium first-year ice which may include old ice inclusions
PC 7	Summer/autumn operation in thin first-year ice which may include old ice inclusions

I1.3 Upper and Lower Ice Waterlines

I1.3.1 The upper and lower ice waterlines upon which the design of the ship has been based is to be indicated in the Certificate of Classification. The upper ice waterline (UIWL) is to be defined by the maximum draughts fore, amidships and aft. The lower ice waterline (LIWL) is to be defined by the minimum draughts fore, amidships and aft.

I1.3.2 The lower ice waterline is to be determined with due regard to the ship's ice-going capability in the ballast loading conditions. The propeller is to be fully submerged at the lower ice waterline.

End of Document

I2 Structural Requirements for Polar Class Ships

(August 2006)
 (Rev.1 Jan 2007)
 (Corr.1 Oct 2007)
 (Rev.2 Nov 2010)
 (Rev.3 Apr 2016)

I2.1 Application *

I2.1.1 This UR applies to Polar Class ships according to UR I1.

I2.2 Hull areas

I2.2.1 The hull of Polar Class ships is divided into areas reflecting the magnitude of the loads that are expected to act upon them. In the longitudinal direction, there are four regions: Bow, Bow Intermediate, Midbody and Stern. The Bow Intermediate, Midbody and Stern regions are further divided in the vertical direction into the Bottom, Lower and Icebelt regions. The extent of each hull area is illustrated in Figure 1.

Figure 1 - Hull area extents

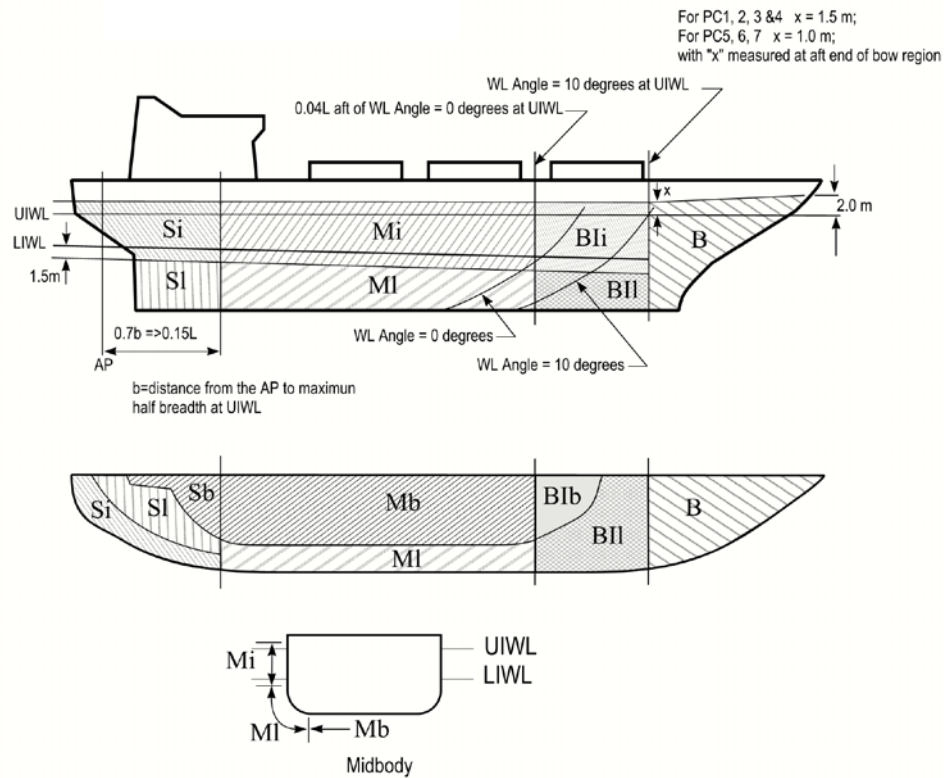

* Note:

1. UR I2 applies to ships contracted for construction on or after 1 July 2007.
2. Rev.1 of this UR is to be uniformly applied by IACS Societies on ships contracted for construction on and after 1 March 2008.
3. Rev.2 of this UR is to be uniformly implemented by the IACS Societies on ships contracted for construction on or after 1 January 2012.
4. Rev.3 of this UR is to be uniformly implemented by the IACS Societies on ships contracted for construction on or after 1 July 2017.
5. The "contracted for construction" date means the date on which the contract to build the vessel is signed between the prospective owner and the shipbuilder. For further details regarding the date of "contract for construction", refer to IACS Procedural Requirement (PR) No. 29.

I2 (cont)

I2.2.2 The upper ice waterline (UIWL) and lower ice waterline (LIWL) are as defined in UR I1.3.

I2.2.3 Figure 1 notwithstanding, at no time is the boundary between the Bow and Bow Intermediate regions to be forward of the intersection point of the line of the stem and the ship baseline.

I2.2.4 Figure 1 notwithstanding, the aft boundary of the Bow region need not be more than 0.45 L aft of the forward perpendicular (FP).

I2.2.5 The boundary between the bottom and lower regions is to be taken at the point where the shell is inclined 7° from horizontal.

I2.2.6 If a ship is intended to operate astern in ice regions, the aft section of the ship is to be designed using the Bow and Bow Intermediate hull area requirements.

I2.2.7 Figure 1 notwithstanding, if the ship is assigned the additional notation "Icebreaker", the forward boundary of the stern region is to be at least 0.04 L forward of the section where the parallel ship side at the upper ice waterline (UIWL) ends.

I2.3 Design ice loads

I2.3.1 General

(i) A glancing impact on the bow is the design scenario for determining the scantlings required to resist ice loads.

(ii) The design ice load is characterized by an average pressure (P_{avg}) uniformly distributed over a rectangular load patch of height (b) and width (w).

(iii) Within the Bow area of all Polar Class ships, and within the Bow Intermediate Icebelt area of Polar Class PC6 and PC7, the ice load parameters are functions of the actual bow shape. To determine the ice load parameters (P_{avg} , b and w), it is required to calculate the following ice load characteristics for sub-regions of the bow area; shape coefficient (f_{a_i}), total glancing impact force (F_i), line load (Q_i) and pressure (P_i).

(iv) In other ice-strengthened areas, the ice load parameters (P_{avg} , b_{NonBow} and w_{NonBow}) are determined independently of the hull shape and based on a fixed load patch aspect ratio, $AR = 3.6$.

(v) Design ice forces calculated according to I2.3.2.1 (iii) are applicable for bow forms where the buttock angle γ at the stem is positive and less than 80 deg, and the normal frame angle β' at the centre of the foremost sub-region, as defined in I2.3.2.1 (i), is greater than 10 deg.

(vi) Design ice forces calculated according to I2.3.2.1 (iv) are applicable for ships which are assigned the Polar Class PC6 or PC7 and have a bow form with vertical sides. This includes bows where the normal frame angles β' at the considered sub-regions, as defined in I2.3.2.1 (i), are between 0 and 10 deg.

(vii) For ships which are assigned the Polar Class PC6 or PC7, and equipped with bulbous bows, the design ice forces on the bow are to be determined according to I2.3.2.1 (iv). In addition, the design forces are not to be taken less than those given in I2.3.2.1 (iii), assuming $f_a = 0.6$ and $AR = 1.3$.

I2 (cont)

(viii) For ships with bow forms other than those defined in (v) to (vii), design forces are to be specially considered by the Classification Society.

(ix) Ship structures that are not directly subjected to ice loads may still experience inertial loads of stowed cargo and equipment resulting from ship/ice interaction. These inertial loads, based on accelerations determined by the Classification Society, are to be considered in the design of these structures.

I2.3.2 Glancing impact load characteristics

The parameters defining the glancing impact load characteristics are reflected in the Class Factors listed in Table 1 and Table 2.

Table 1 - Class factors to be used in I2.3.2.1 (iii)

Polar Class	Crushing failure Class Factor (CF _C)	Flexural failure Class Factor (CF _F)	Load patch dimensions Class Factor (CF _D)	Displacement Class Factor (CF _{DIS})	Longitudinal strength Class Factor (CF _L)
PC1	17.69	68.60	2.01	250	7.46
PC2	9.89	46.80	1.75	210	5.46
PC3	6.06	21.17	1.53	180	4.17
PC4	4.50	13.48	1.42	130	3.15
PC5	3.10	9.00	1.31	70	2.50
PC6	2.40	5.49	1.17	40	2.37
PC7	1.80	4.06	1.11	22	1.81

Table 2 - Class factors to be used in I2.3.2.1 (iv)

Polar Class	Crushing failure Class Factor (CF _{CV})	Line load Class Factor (CF _{QV})	Pressure Class Factor (CF _{PV})
PC6	3.43	2.82	0.65
PC7	2.60	2.33	0.65

I2.3.2.1 Bow area

(i) In the Bow area, the force (F), line load (Q), pressure (P) and load patch aspect ratio (AR) associated with the glancing impact load scenario are functions of the hull angles measured at the upper ice waterline (UIWL). The influence of the hull angles is captured through calculation of a bow shape coefficient (fa). The hull angles are defined in Figure 2.

I2 (cont)

Figure 2 - Definition of hull angles

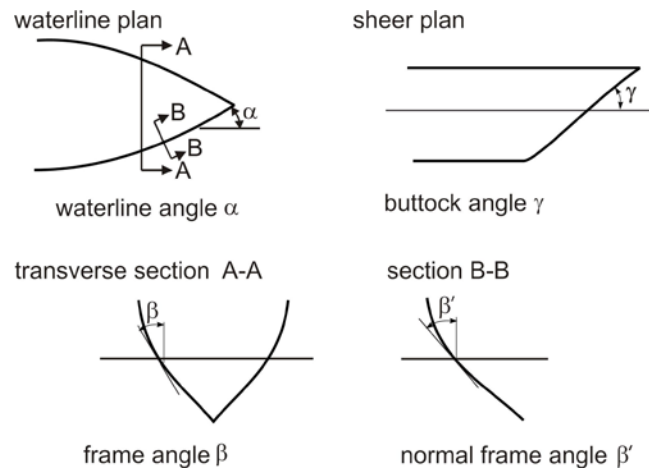

Note: β' = normal frame angle at upper ice waterline [deg]

α = upper ice waterline angle [deg]

γ = buttock angle at upper ice waterline (angle of buttock line measured from horizontal) [deg]

$\tan(\beta) = \tan(\alpha)/\tan(\gamma)$

$\tan(\beta') = \tan(\beta) \cdot \cos(\alpha)$

(ii) The waterline length of the bow region is generally to be divided into 4 sub-regions of equal length. The force (F), line load (Q), pressure (P) and load patch aspect ratio (AR) are to be calculated with respect to the mid-length position of each sub-region (each maximum of F, Q and P is to be used in the calculation of the ice load parameters P_{avg} , b and w).

(iii) The Bow area load characteristics for bow forms defined in I2.3.1 (v) are determined as follows:

(a) Shape coefficient, fa_i , is to be taken as

$$fa_i = \text{minimum}(fa_{i,1}; fa_{i,2}; fa_{i,3})$$

$$\text{where } fa_{i,1} = (0.097 - 0.68 \cdot (x/L - 0.15)^2) \cdot \alpha_i / (\beta'_i)^{0.5}$$

$$fa_{i,2} = 1.2 \cdot CF_F / (\sin(\beta'_i) \cdot CF_C \cdot D^{0.64})$$

$$fa_{i,3} = 0.60$$

(b) Force, F_i :

$$F_i = fa_i \cdot CF_C \cdot D^{0.64} \text{ [MN]}$$

(c) Load patch aspect ratio, AR_i :

$$AR_i = 7.46 \cdot \sin(\beta'_i) \geq 1.3$$

(d) Line load, Q_i :

$$Q_i = F_i^{0.61} \cdot CF_D / AR_i^{0.35} \text{ [MN/m]}$$

I2 (cont)

(e) Pressure, P_i :

$$P_i = F_i^{0.22} \cdot CF_D^2 \cdot AR_i^{0.3} \text{ [MPa]}$$

where i = sub-region considered

L = ship length as defined in UR S2.1, but measured on the upper ice waterline (UIWL) [m]

x = distance from the forward perpendicular (FP) to station under consideration [m]

α = waterline angle [deg], see Figure 2

β' = normal frame angle [deg], see Figure 2

D = ship displacement [kt], not to be taken less than 5 kt

CF_C = Crushing failure Class Factor from Table 1

CF_F = Flexural failure Class Factor from Table 1

CF_D = Load patch dimensions Class Factor from Table 1

(iv) The Bow area load characteristics for bow forms defined in I2.3.1 (vi) are determined as follows:

(a) Shape coefficient, fa_i , is to be taken as

$$fa_i = \alpha_i / 30$$

(b) Force, F_i :

$$F_i = fa_i \cdot CF_{CV} \cdot D^{0.47} \text{ [MN]}$$

(c) Line load, Q_i :

$$Q_i = F_i^{0.22} \cdot CF_{QV} \text{ [MN/m]}$$

(d) Pressure, P_i :

$$P_i = F_i^{0.56} \cdot CF_{PV} \text{ [MPa]}$$

where i = sub-region considered

α = waterline angle [deg], see Figure 2

D = ship displacement [kt], not to be taken less than 5 kt

CF_{CV} = Crushing failure Class Factor from Table 2

CF_{QV} = Line load Class Factor from Table 2

CF_{PV} = Pressure Class Factor from Table 2

I2.3.2.2 Hull areas other than the bow

(i) In the hull areas other than the bow, the force (F_{NonBow}) and line load (Q_{NonBow}) used in the determination of the load patch dimensions (b_{NonBow} , w_{NonBow}) and design pressure (P_{avg}) are determined as follows:

(a) Force, F_{NonBow} :

$$F_{\text{NonBow}} = 0.36 \cdot CF_C \cdot DF \text{ [MN]}$$

I2 (cont)

(b) Line Load, Q_{NonBow} :

$$Q_{\text{NonBow}} = 0.639 \cdot F_{\text{NonBow}}^{0.61} \cdot CF_D \text{ [MN/m]}$$

where CF_C = Crushing failure Class Factor from Table 1

DF = ship displacement factor

$$= D^{0.64} \quad \text{if } D \leq CF_{\text{DIS}}$$

$$= CF_{\text{DIS}}^{0.64} + 0.10 \cdot (D - CF_{\text{DIS}}) \quad \text{if } D > CF_{\text{DIS}}$$

D = ship displacement [kt], not to be taken less than 10 kt

CF_{DIS} = Displacement Class Factor from Table 1

CF_D = Load patch dimensions Class Factor from Table 1

I2.3.3 Design load patch

(i) In the Bow area, and the Bow Intermediate Icebelt area for ships with class notation PC6 and PC7, the design load patch has dimensions of width, w_{Bow} , and height, b_{Bow} , defined as follows:

$$w_{\text{Bow}} = F_{\text{Bow}} / Q_{\text{Bow}} \text{ [m]}$$

$$b_{\text{Bow}} = Q_{\text{Bow}} / P_{\text{Bow}} \text{ [m]}$$

where F_{Bow} = maximum force F_i in the Bow area [MN]

Q_{Bow} = maximum line load Q_i in the Bow area [MN/m]

P_{Bow} = maximum pressure P_i in the Bow area [MPa]

(ii) In hull areas other than those covered by I2.3.3 (i), the design load patch has dimensions of width, w_{NonBow} , and height, b_{NonBow} , defined as follows:

$$w_{\text{NonBow}} = F_{\text{NonBow}} / Q_{\text{NonBow}} \text{ [m]}$$

$$b_{\text{NonBow}} = w_{\text{NonBow}} / 3.6 \text{ [m]}$$

where F_{NonBow} = force as defined in I2.3.2.2 (i) (a) [MN]

Q_{NonBow} = line load as defined in I2.3.2.2 (i) (b) [MN/m]

I2.3.4 Pressure within the design load patch

(i) The average pressure, P_{avg} , within a design load patch is determined as follows:

$$P_{\text{avg}} = F / (b \cdot w) \text{ [MPa]}$$

where $F = F_{\text{Bow}}$ or F_{NonBow} as appropriate for the hull area under consideration [MN]

$b = b_{\text{Bow}}$ or b_{NonBow} as appropriate for the hull area under consideration [m]

$w = w_{\text{Bow}}$ or w_{NonBow} as appropriate for the hull area under consideration [m]

(ii) Areas of higher, concentrated pressure exist within the load patch. In general, smaller areas have higher local pressures. Accordingly, the peak pressure factors listed in Table 3 are used to account for the pressure concentration on localized structural members.

I2 (cont)

Table 3 - Peak Pressure Factors

Structural member		Peak Pressure Factor (PPF _i)
Plating	Transversely-framed	$PPF_p = (1.8 - s) \geq 1.2$
	Longitudinally-framed	$PPF_p = (2.2 - 1.2 \cdot s) \geq 1.5$
Frames in transverse framing systems	With load distributing stringers	$PPF_t = (1.6 - s) \geq 1.0$
	With no load distributing stringers	$PPF_t = (1.8 - s) \geq 1.2$
Frames in bottom structures		$PPF_s = 1.0$
Load carrying stringers		$PPF_s = 1.0$, if $S_w \geq 0.5 \cdot w$
Side longitudinals		$PPF_s = 2.0 - 2.0 \cdot S_w / w$,
Web frames		if $S_w < (0.5 \cdot w)$
where: s = frame or longitudinal spacing [m] S_w = web frame spacing [m] w = ice load patch width [m]		

I2.3.5 Hull area factors

- (i) Associated with each hull area is an Area Factor that reflects the relative magnitude of the load expected in that area. The Area Factor (AF) for each hull area is listed in Table 4.
- (ii) In the event that a structural member spans across the boundary of a hull area, the largest hull area factor is to be used in the scantling determination of the member.
- (iii) Due to their increased manoeuvrability, ships having propulsion arrangements with azimuth thruster(s) or “podded” propellers are to have specially considered Stern Icebelt (S_i) and Stern Lower (S_l) hull area factors.
- (iv) For ships assigned the additional notation “Icebreaker”, the Area Factor (AF) for each hull area is listed in Table 5.

Table 4 - Hull Area Factors (AF)

Hull area		Area	Polar Class						
			PC1	PC2	PC3	PC4	PC5	PC6	PC7
Bow (B)	All	B	1.00	1.00	1.00	1.00	1.00	1.00	1.00
Bow Intermediate (BI)	Icebelt	BI _i	0.90	0.85	0.85	0.80	0.80	1.00*	1.00*
	Lower	BI _l	0.70	0.65	0.65	0.60	0.55	0.55	0.50
	Bottom	BI _b	0.55	0.50	0.45	0.40	0.35	0.30	0.25
Midbody (M)	Icebelt	M _i	0.70	0.65	0.55	0.55	0.50	0.45	0.45
	Lower	M _l	0.50	0.45	0.40	0.35	0.30	0.25	0.25
	Bottom	M _b	0.30	0.30	0.25	**	**	**	**
Stern (S)	Icebelt	S _i	0.75	0.70	0.65	0.60	0.50	0.40	0.35
	Lower	S _l	0.45	0.40	0.35	0.30	0.25	0.25	0.25
	Bottom	S _b	0.35	0.30	0.30	0.25	0.15	**	**

Note to Table 4: * See I2.3.1 (iii).

** Indicates that strengthening for ice loads is not necessary.

I2 (cont)

Table 5 - Hull Area Factors (AF) for ships with additional notation “Icebreaker”

Hull area		Area	Polar Class						
			PC1	PC2	PC3	PC4	PC5	PC6	PC7
Bow (B)	All	B	1.00	1.00	1.00	1.00	1.00	1.00	1.00
Bow Intermediate (BI)	Icebelt	BI _i	0.90	0.85	0.85	0.85	0.85	1.00	1.00
	Lower	BI _l	0.70	0.65	0.65	0.65	0.65	0.65	0.65
	Bottom	BI _b	0.55	0.50	0.45	0.45	0.45	0.45	0.45
Midbody (M)	Icebelt	M _i	0.70	0.65	0.55	0.55	0.55	0.55	0.55
	Lower	M _l	0.50	0.45	0.40	0.40	0.40	0.40	0.40
	Bottom	M _b	0.30	0.30	0.25	0.25	0.25	0.25	0.25
Stern (S)	Icebelt	S _i	0.95	0.90	0.80	0.80	0.80	0.80	0.80
	Lower	S _l	0.55	0.50	0.45	0.45	0.45	0.45	0.45
	Bottom	S _b	0.35	0.30	0.30	0.30	0.30	0.30	0.30

I2.4 Shell plate requirements

I2.4.1 The required minimum shell plate thickness, t , is given by:

$$t = t_{\text{net}} + t_s \text{ [mm]}$$

where t_{net} = plate thickness required to resist ice loads according to I2.4.2 [mm]
 t_s = corrosion and abrasion allowance according to I2.11 [mm]

I2.4.2 The thickness of shell plating required to resist the design ice load, t_{net} , depends on the orientation of the framing.

In the case of transversely-framed plating ($\Omega \geq 70$ deg), including all bottom plating, i.e. plating in hull areas BI_b, M_b and S_b, the net thickness is given by:

$$t_{\text{net}} = 500 \cdot s \cdot ((AF \cdot PPF_p \cdot P_{\text{avg}}) / \sigma_y)^{0.5} / (1 + s / (2 \cdot b)) \text{ [mm]}$$

In the case of longitudinally-framed plating ($\Omega \leq 20$ deg), when $b \geq s$, the net thickness is given by:

$$t_{\text{net}} = 500 \cdot s \cdot ((AF \cdot PPF_p \cdot P_{\text{avg}}) / \sigma_y)^{0.5} / (1 + s / (2 \cdot l)) \text{ [mm]}$$

In the case of longitudinally-framed plating ($\Omega \leq 20$ deg), when $b < s$, the net thickness is given by:

$$t_{\text{net}} = 500 \cdot s \cdot ((AF \cdot PPF_p \cdot P_{\text{avg}}) / \sigma_y)^{0.5} \cdot (2 \cdot b / s - (b / s)^2)^{0.5} / (1 + s / (2 \cdot l)) \text{ [mm]}$$

In the case of obliquely-framed plating ($70 \text{ deg} > \Omega > 20 \text{ deg}$), linear interpolation is to be used.

where Ω = smallest angle between the chord of the waterline and the line of the first level framing as illustrated in Figure 3 [deg].
 s = transverse frame spacing in transversely-framed ships or longitudinal frame spacing in longitudinally-framed ships [m]
 AF = Hull Area Factor from Table 4 or Table 5
 PPF_p = Peak Pressure Factor from Table 3
 P_{avg} = average patch pressure as defined in I2.3.4 [MPa]

I2 (cont)

σ_y = minimum upper yield stress of the material [N/mm²]

b = height of design load patch [m], where b is to be taken not greater than $(l - s/4)$ in the case of determination of the net thickness for transversely framed plating

l = distance between frame supports, i.e. equal to the frame span as given in I2.5.5, but not reduced for any fitted end brackets [m]. When a load-distributing stringer is fitted, the length l need not be taken larger than the distance from the stringer to the most distant frame support.

Figure 3 - Shell framing angle Ω

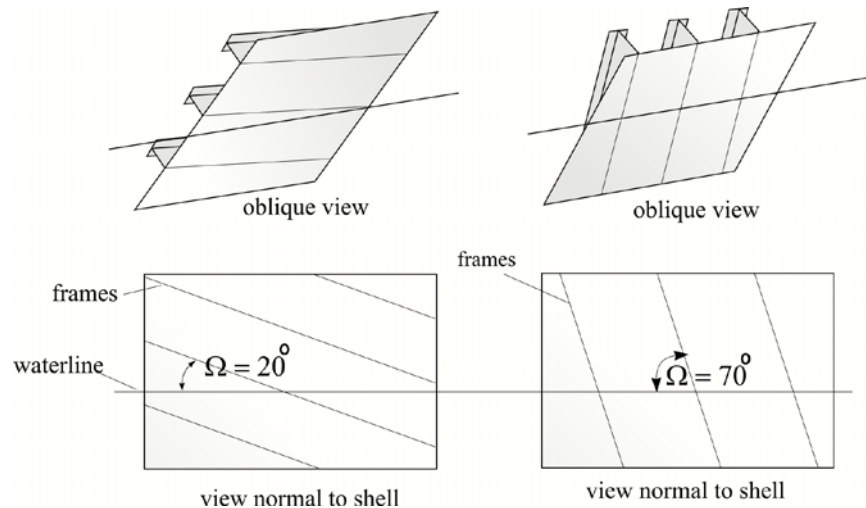

I2.5 Framing - General

I2.5.1 Framing members of Polar Class ships are to be designed to withstand the ice loads defined in I2.3.

I2.5.2 The term “framing member” refers to transverse and longitudinal local frames, load-carrying stringers and web frames in the areas of the hull exposed to ice pressure, see Figure 1. Where load-distributing stringers have been fitted, the arrangement and scantlings of these are to be in accordance with the requirements of the Classification Society.

I2.5.3 The strength of a framing member is dependent upon the fixity that is provided at its supports. Fixity can be assumed where framing members are either continuous through the support or attached to a supporting section with a connection bracket. In other cases, simple support is to be assumed unless the connection can be demonstrated to provide significant rotational restraint. Fixity is to be ensured at the support of any framing which terminates within an ice-strengthened area.

I2.5.4 The details of framing member intersection with other framing members, including plated structures, as well as the details for securing the ends of framing members at supporting sections, are to be in accordance with the requirements of the Classification Society.

I2.5.5 The effective span of a framing member is to be determined on the basis of its moulded length. If brackets are fitted, the effective span may be reduced in accordance with the usual practice of the Classification Society. Brackets are to be configured to ensure stability in the elastic and post-yield response regions.

I2 (cont)

I2.5.6 When calculating the section modulus and shear area of a framing member, net thicknesses of the web, flange (if fitted) and attached shell plating are to be used. The shear area of a framing member may include that material contained over the full depth of the member, i.e. web area including portion of flange, if fitted, but excluding attached shell plating.

I2.5.7 The actual net effective shear area, A_w , of a transverse or longitudinal local frame is given by:

$$A_w = h \cdot t_{wn} \cdot \sin \varphi_w / 100 \text{ [cm}^2\text{]}$$

where

h = height of stiffener [mm], see Figure 4

t_{wn} = net web thickness [mm]

$$= t_w - t_c$$

t_w = as built web thickness [mm], see Figure 4

t_c = corrosion deduction [mm] to be subtracted from the web and flange thickness (as specified by the Classification Society, but not less than t_s as required by I2.11.3).

φ_w = smallest angle between shell plate and stiffener web, measured at the midspan of the stiffener, see Figure 4. The angle φ_w may be taken as 90 deg provided the smallest angle is not less than 75 deg.

Figure 4 - Stiffener geometry

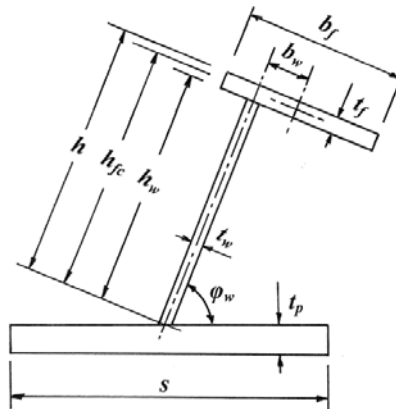

I2.5.8 When the cross-sectional area of the attached plate flange exceeds the cross-sectional area of the local frame, the actual net effective plastic section modulus, Z_p , of a transverse or longitudinal frame is given by:

$$Z_p = A_{pn} \cdot t_{pn} / 20 + \frac{h_w^2 \cdot t_{wn} \cdot \sin \varphi_w}{2000} + A_{fn} \cdot (h_{fc} \cdot \sin \varphi_w - b_w \cdot \cos \varphi_w) / 10 \text{ [cm}^3\text{]}$$

where

h , t_{wn} , t_c , and φ_w as given in I2.5.7 and s as given in I2.4.2.

A_{pn} = net cross-sectional area of the local frame [cm²]

t_{pn} = fitted net shell plate thickness [mm] (complying with t_{net} as required by I2.4.2)

h_w = height of local frame web [mm], see Figure 4

A_{fn} = net cross-sectional area of local frame flange [cm²]

h_{fc} = height of local frame measured to centre of the flange area [mm], see Figure 4

b_w = distance from mid thickness plane of local frame web to the centre of the flange area [mm], see Figure 4

I2 (cont)

When the cross-sectional area of the local frame exceeds the cross-sectional area of the attached plate flange, the plastic neutral axis is located a distance z_{na} above the attached shell plate, given by:

$$z_{na} = (100 \cdot A_{fn} + h_w \cdot t_{wn} - 1000 \cdot t_{pn} \cdot s) / (2 \cdot t_{wn}) \text{ [mm]}$$

and the net effective plastic section modulus, Z_p , of a transverse or longitudinal frame is given by:

$$Z_p = t_{pn} \cdot s \cdot (z_{na} + t_{pn} / 2) \cdot \sin \varphi_w + \left(\frac{((h_w - z_{na})^2 + z_{na}^2) \cdot t_{wn} \cdot \sin \varphi_w}{2000} + A_{fn} \cdot ((h_{fc} - z_{na}) \cdot \sin \varphi_w - b_w \cdot \cos \varphi_w) / 10 \right) \text{ [cm}^3\text{]}$$

I2.5.9 In the case of oblique framing arrangement ($70 \text{ deg} > \Omega > 20 \text{ deg}$, where Ω is defined as given in I2.4.2), linear interpolation is to be used.

I2.6 Framing - Local frames in bottom structures and transverse local frames in side structures

I2.6.1 The local frames in bottom structures (i.e. hull areas B_b , M_b and S_b) and transverse local frames in side structures are to be dimensioned such that the combined effects of shear and bending do not exceed the plastic strength of the member. The plastic strength is defined by the magnitude of midspan load that causes the development of a plastic collapse mechanism.

For bottom structure the patch load shall be applied with the dimension (b) parallel with the frame direction.

I2.6.2 The actual net effective shear area of the frame, A_w , as defined in I2.5.7, is to comply with the following condition: $A_w \geq A_t$, where:

$$A_t = 100^2 \cdot 0.5 \cdot LL \cdot s \cdot (AF \cdot PPF \cdot P_{avg}) / (0.577 \cdot \sigma_y) \text{ [cm}^2\text{]}$$

where LL = length of loaded portion of span

= lesser of a and b [m]

a = local frame span as defined in I2.5.5 [m]

b = height of design ice load patch as defined in I2.3.3 (i) or I2.3.3 (ii) [m]

s = spacing of local frame [m]

AF = Hull Area Factor from Table 4 or Table 5

PPF = Peak Pressure Factor, PPF_t or PPF_s as appropriate from Table 3

P_{avg} = average pressure within load patch as defined in I2.3.4 [MPa]

σ_y = minimum upper yield stress of the material [N/mm²]

I2.6.3 The actual net effective plastic section modulus of the plate/stiffener combination, Z_p , as defined in I2.5.8, is to comply with the following condition: $Z_p \geq Z_{pt}$, where Z_{pt} is to be the greater calculated on the basis of two load conditions: a) ice load acting at the midspan of the local frame, and b) the ice load acting near a support. The A_1 parameter defined below reflects these two conditions:

$$Z_{pt} = 100^3 \cdot LL \cdot Y \cdot s \cdot (AF \cdot PPF \cdot P_{avg}) \cdot a \cdot A_1 / (4 \cdot \sigma_y) \text{ [cm}^3\text{]}$$

where AF, PPF, P_{avg} , LL, b, s, a and σ_y are as given in I2.6.2

$$Y = 1 - 0.5 \cdot (LL / a)$$

I2 (cont)

A_1 = maximum of

$$A_{1A} = 1 / (1 + j / 2 + k_w \cdot j / 2 \cdot [(1 - a_1^2)^{0.5} - 1])$$

$$A_{1B} = (1 - 1 / (2 \cdot a_1 \cdot Y)) / (0.275 + 1.44 \cdot k_z^{0.7})$$

$j = 1$ for a local frame with one simple support outside the ice-strengthened areas

$= 2$ for a local frame without any simple supports

$$a_1 = A_t / A_w$$

A_t = minimum shear area of the local frame as given in I2.6.2 [cm²]

A_w = effective net shear area of the local frame (calculated according to I2.5.7) [cm²]

$k_w = 1 / (1 + 2 \cdot A_{fn} / A_w)$ with A_{fn} as given in I2.5.8

$k_z = z_p / Z_p$ in general

$= 0.0$ when the frame is arranged with end bracket

z_p = sum of individual plastic section moduli of flange and shell plate as fitted [cm³]

$$= (b_f \cdot t_{fn}^2 / 4 + b_{eff} \cdot t_{pn}^2 / 4) / 1000$$

b_f = flange breadth [mm], see Figure 4

t_{fn} = net flange thickness [mm]

$$= t_f - t_c \text{ (} t_c \text{ as given in I2.5.7)}$$

t_f = as-built flange thickness [mm], see Figure 4

t_{pn} = the fitted net shell plate thickness [mm] (not to be less than t_{net} as given in I2.4)

b_{eff} = effective width of shell plate flange [mm]

$$= 500 \cdot s$$

Z_p = net effective plastic section modulus of the local frame (calculated according to I2.5.8) [cm³]

I2.6.4 The scantlings of the local frame are to meet the structural stability requirements of I2.9.

I2.7 Framing - Longitudinal local frames in side structures

I2.7.1 Longitudinal local frames in side structures are to be dimensioned such that the combined effects of shear and bending do not exceed the plastic strength of the member. The plastic strength is defined by the magnitude of midspan load that causes the development of a plastic collapse mechanism.

I2.7.2 The actual net effective shear area of the frame, A_w , as defined in I2.5.7, is to comply with the following condition: $A_w \geq A_L$, where:

$$A_L = 100^2 \cdot (AF \cdot PPF_s \cdot P_{avg}) \cdot 0.5 \cdot b_1 \cdot a / (0.577 \cdot \sigma_y) \text{ [cm}^2\text{]}$$

where AF = Hull Area Factor from Table 4 or Table 5

PPF_s = Peak Pressure Factor from Table 3

P_{avg} = average pressure within load patch as defined in I2.3.4 [MPa]

$$b_1 = k_o \cdot b_2 \text{ [m]}$$

$$k_o = 1 - 0.3 / b'$$

$$b' = b / s$$

b = height of design ice load patch as defined in I2.3.3 (i) or I2.3.3 (ii) [m]

s = spacing of longitudinal frames [m]

$$b_2 = b \cdot (1 - 0.25 \cdot b') \text{ [m], if } b' < 2$$

$$= s \text{ [m], if } b' \geq 2$$

a = effective span of longitudinal local frame as given in I2.5.5 [m]

σ_y = minimum upper yield stress of the material [N/mm²]

I2 (cont)

I2.7.3 The actual net effective plastic section modulus of the plate/stiffener combination, Z_p , as defined in I2.5.8, is to comply with the following condition: $Z_p \geq Z_{pL}$, where:

$$Z_{pL} = 100^3 \cdot (AF \cdot PPF_s \cdot P_{avg}) \cdot b_1 \cdot a^2 \cdot A_4 / (8 \cdot \sigma_y) \text{ [cm}^3\text{]}$$

where AF , PPF_s , P_{avg} , b_1 , a and σ_y are as given in I2.7.2

$$A_4 = 1 / (2 + k_{wl} \cdot [(1 - a_4^2)^{0.5} - 1])$$

$$a_4 = A_L / A_w$$

A_L = minimum shear area for longitudinal as given in I2.7.2 [cm²]

A_w = net effective shear area of longitudinal (calculated according to I2.5.7) [cm²]

$k_{wl} = 1 / (1 + 2 \cdot A_{fn} / A_w)$ with A_{fn} as given in I2.5.8

I2.7.4 The scantlings of the longitudinals are to meet the structural stability requirements of I2.9.

I2.8 Framing - Web frames and load carrying stringers

I2.8.1 Web frames and load-carrying stringers are to be designed to withstand the ice load patch as defined in I2.3. The load patch is to be applied at locations where the capacity of these members under the combined effects of bending and shear is minimised.

I2.8.2 Web frames and load-carrying stringers are to be dimensioned such that the combined effects of shear and bending do not exceed the limit state(s) defined by the Classification Society. Where the structural configuration is such that members do not form part of a grillage system, the appropriate peak pressure factor (PPF) from Table 3 is to be used. Special attention is to be paid to the shear capacity in way of lightening holes and cut-outs in way of intersecting members.

I2.8.3 For determination of scantlings of load carrying stringers, web frames supporting local frames, or web frames supporting load carrying stringers forming part of a structural grillage system, appropriate methods as outlined in I2.17 are normally to be used.

I2.8.4 The scantlings of web frames and load-carrying stringers are to meet the structural stability requirements of I2.9.

I2.9 Framing - Structural stability

I2.9.1 To prevent local buckling in the web, the ratio of web height (h_w) to net web thickness (t_{wn}) of any framing member is not to exceed:

For flat bar sections:
$$h_w / t_{wn} \leq 282 / (\sigma_y)^{0.5}$$

For bulb, tee and angle sections:
$$h_w / t_{wn} \leq 805 / (\sigma_y)^{0.5}$$

where h_w = web height

t_{wn} = net web thickness

σ_y = minimum upper yield stress of the material [N/mm²]

I2.9.2 Framing members for which it is not practicable to meet the requirements of I2.9.1 (e.g. load carrying stringers or deep web frames) are required to have their webs effectively stiffened. The scantlings of the web stiffeners are to ensure the structural stability of the framing member. The minimum net web thickness for these framing members is given by:

12

(cont)

$$t_{wn} = 2.63 \cdot 10^{-3} \cdot c_1 \cdot (\sigma_y / (5.34 + 4 \cdot (c_1 / c_2)^2))^{0.5} \text{ [mm]}$$

where $c_1 = h_w - 0.8 \cdot h$ [mm]

h_w = web height of stringer / web frame [mm] (see Figure 5)

h = height of framing member penetrating the member under consideration (0 if no such framing member) [mm] (see Figure 5)

c_2 = spacing between supporting structure oriented perpendicular to the member under consideration [mm] (see Figure 5)

σ_y = minimum upper yield stress of the material [N/mm²]

Figure 5 - Parameter definition of web stiffening

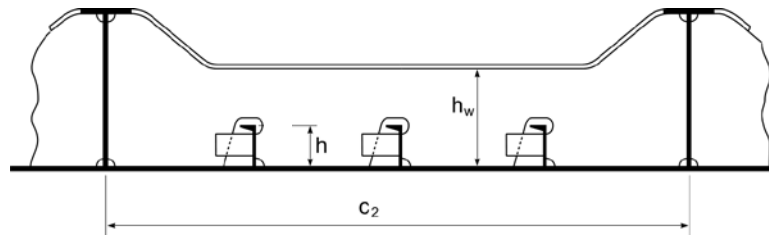

12.9.3 In addition, the following is to be satisfied:

$$t_{wn} \geq 0.35 \cdot t_{pn} \cdot (\sigma_y / 235)^{0.5}$$

where σ_y = minimum upper yield stress of the shell plate in way of the framing member [N/mm²]

t_{wn} = net thickness of the web [mm]

t_{pn} = net thickness of the shell plate in way of the framing member [mm]

12.9.4 To prevent local flange buckling of welded profiles, the following are to be satisfied:

(i) The flange width, b_f [mm], is not to be less than five times the net thickness of the web, t_{wn} .

(ii) The flange outstand, b_{out} [mm], is to meet the following requirement:

$$b_{out} / t_{fn} \leq 155 / (\sigma_y)^{0.5}$$

where t_{fn} = net thickness of flange [mm]

σ_y = minimum upper yield stress of the material [N/mm²]

12.10 Plated structures

12.10.1 Plated structures are those stiffened plate elements in contact with the hull and subject to ice loads. These requirements are applicable to an inboard extent which is the lesser of:

- (i) web height of adjacent parallel web frame or stringer; or
- (ii) 2.5 times the depth of framing that intersects the plated structure

12.10.2 The thickness of the plating and the scantlings of attached stiffeners are to be such that the degree of end fixity necessary for the shell framing is ensured.

I2 (cont)

I2.10.3 The stability of the plated structure is to adequately withstand the ice loads defined in I2.3.

I2.11 Corrosion/abrasion additions and steel renewal

I2.11.1 Effective protection against corrosion and ice-induced abrasion is recommended for all external surfaces of the shell plating for Polar Class ships.

I2.11.2 The values of corrosion/abrasion additions, t_s , to be used in determining the shell plate thickness are listed in Table 6.

I2.11.3 Polar Class ships are to have a minimum corrosion/abrasion addition of $t_s = 1.0$ mm applied to all internal structures within the ice-strengthened hull areas, including plated members adjacent to the shell, as well as stiffener webs and flanges.

Table 6 - Corrosion/abrasion additions for shell plating

Hull area	t_s [mm]					
	With effective protection			Without effective protection		
	PC1 - PC3	PC4 & PC5	PC6 & PC7	PC1 - PC3	PC4 & PC5	PC6 & PC7
Bow; Bow Intermediate Icebelt	3.5	2.5	2.0	7.0	5.0	4.0
Bow Intermediate Lower; Midbody & Stern Icebelt	2.5	2.0	2.0	5.0	4.0	3.0
Midbody & Stern Lower; Bottom	2.0	2.0	2.0	4.0	3.0	2.5

I2.11.4 Steel renewal for ice strengthened structures is required when the gauged thickness is less than $t_{net} + 0.5$ mm.

I2.12 Materials

I2.12.1 Steel grades of plating for hull structures are to be not less than those given in Table 8 based on the as-built thickness, the Polar Class and the material class of structural members according to I2.12.2.

I2

(cont)

Table 7 - Material classes for structural members

Structural members	Material class
Shell plating within the bow and bow intermediate icebelt hull areas (B, B _{ii})	II
All weather and sea exposed SECONDARY and PRIMARY, as defined in Table 1 of UR S6.1, structural members outside 0.4L amidships	I
Plating materials for stem and stern frames, rudder horn, rudder, propeller nozzle, shaft brackets, ice skeg, ice knife and other appendages subject to ice impact loads	II
All inboard framing members attached to the weather and sea-exposed plating, including any contiguous inboard member within 600 mm of the plating	I
Weather-exposed plating and attached framing in cargo holds of ships which by nature of their trade have their cargo hold hatches open during cold weather operations	I
All weather and sea exposed SPECIAL, as defined in Table 1 of UR S6.1, structural members within 0.2L from FP	II

I2.12.2 Material classes specified in Table 1 of UR S6.1 are applicable to Polar Class ships regardless of the ship's length. In addition, material classes for weather and sea exposed structural members and for members attached to the weather and sea exposed plating are given in Table 7. Where the material classes in Table 7 and those in Table 1 of UR S6.1 differ, the higher material class is to be applied.

I2.12.3 Steel grades for all plating and attached framing of hull structures and appendages situated below the level of 0.3 m below the lower waterline, as shown in Figure 6, are to be obtained from Table 6 and Table 7 of UR S6 based on the material class for structural members in Table 7 above, regardless of Polar Class.

Figure 6 - Steel grade requirements for submerged and weather exposed shell plating

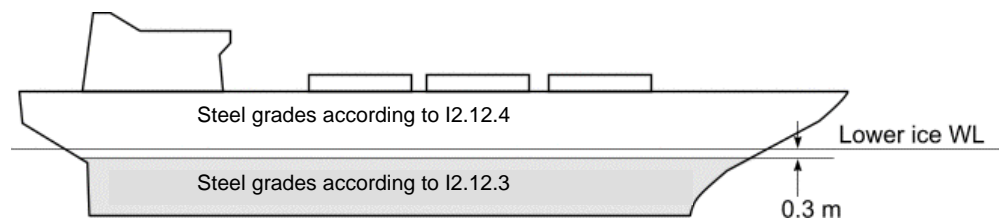

I2.12.4 Steel grades for all weather exposed plating of hull structures and appendages situated above the level of 0.3 m below the lower ice waterline, as shown in Figure 6, are to be not less than given in Table 8.

I2

(cont)

Table 8 - Steel grades for weather exposed plating¹⁾

Thickness, t [mm]	Material class I				Material class II				Material class III					
	PC1-5		PC6&7		PC1-5		PC6&7		PC1-3		PC4&5		PC6&7	
	MS	HT	MS	HT	MS	HT	MS	HT	MS	HT	MS	HT	MS	HT
$t \leq 10$	B	AH	B	AH	B	AH	B	AH	E	EH	E	EH	B	AH
$10 < t \leq 15$	B	AH	B	AH	D	DH	B	AH	E	EH	E	EH	D	DH
$15 < t \leq 20$	D	DH	B	AH	D	DH	B	AH	E	EH	E	EH	D	DH
$20 < t \leq 25$	D	DH	B	AH	D	DH	B	AH	E	EH	E	EH	D	DH
$25 < t \leq 30$	D	DH	B	AH	E	EH ²⁾	D	DH	E	EH	E	EH	E	EH
$30 < t \leq 35$	D	DH	B	AH	E	EH	D	DH	E	EH	E	EH	E	EH
$35 < t \leq 40$	D	DH	D	DH	E	EH	D	DH	F	FH	E	EH	E	EH
$40 < t \leq 45$	E	EH	D	DH	E	EH	D	DH	F	FH	E	EH	E	EH
$45 < t \leq 50$	E	EH	D	DH	E	EH	D	DH	F	FH	F	FH	E	EH

Notes to Table 8:

1) Includes weather-exposed plating of hull structures and appendages, as well as their outboard framing members, situated above a level of 0.3 m below the lowest ice waterline.

2) Grades D, DH are allowed for a single strake of side shell plating not more than 1.8 m wide from 0.3 m below the lowest ice waterline.

I2.12.5 Castings are to have specified properties consistent with the expected service temperature for the cast component.

I2.13 Longitudinal strength

I2.13.1 Application

I2.13.1.1 A ramming impact on the bow is the design scenario for the evaluation of the longitudinal strength of the hull.

I2.13.1.2 Intentional ramming is not considered as a design scenario for ships which are designed with vertical or bulbous bows, see I1.1.6. Hence the longitudinal strength requirements given in I2.13 is not to be considered for ships with stem angle γ_{stem} equal to or larger than 80 deg.

I2.13.1.3 Ice loads are only to be combined with still water loads. The combined stresses are to be compared against permissible bending and shear stresses at different locations along the ship's length. In addition, sufficient local buckling strength is also to be verified.

I2.13.2 Design vertical ice force at the bow

I2.13.2.1 The design vertical ice force at the bow, F_{IB} , is to be taken as

$$F_{IB} = \text{minimum} (F_{IB,1}; F_{IB,2}) \text{ [MN]}$$

$$\text{where } F_{IB,1} = 0.534 \cdot K_1^{0.15} \cdot \sin^{0.2}(\gamma_{\text{stem}}) \cdot (D \cdot K_h)^{0.5} \cdot CF_L \text{ [MN]}$$

$$F_{IB,2} = 1.20 \cdot CF_F \text{ [MN]}$$

I2 (cont)

K_I = indentation parameter = K_f / K_h

a) for the case of a blunt bow form

$$K_f = (2 \cdot C \cdot B^{1-e_b} / (1 + e_b))^{0.9} \cdot \tan(\gamma_{\text{stem}})^{-0.9 \cdot (1 + e_b)}$$

b) for the case of wedge bow form ($\alpha_{\text{stem}} < 80$ deg), $e_b = 1$ and the above simplifies to

$$K_f = (\tan(\alpha_{\text{stem}}) / \tan^2(\gamma_{\text{stem}}))^{0.9}$$

$$K_h = 0.01 \cdot A_{\text{wp}} \text{ [MN/m]}$$

CF_L = Longitudinal Strength Class Factor from Table 1

e_b = bow shape exponent which best describes the waterplane (see Figures 7 and 8)

= 1.0 for a simple wedge bow form

= 0.4 to 0.6 for a spoon bow form

= 0 for a landing craft bow form

An approximate e_b determined by a simple fit is acceptable

γ_{stem} = stem angle to be measured between the horizontal axis and the stem tangent at the upper ice waterline [deg] (buttock angle as per Figure 2 measured on the centreline)

α_{stem} = waterline angle measured in way of the stem at the upper ice waterline (UIWL) [deg] (see Figure 7)

$$C = 1 / (2 \cdot (L_B / B)^{e_b})$$

B = ship moulded breadth [m]

L_B = bow length used in the equation $y = B / 2 \cdot (x/L_B)^{e_b}$ [m] (see Figures 7 and 8)

D = ship displacement [kt], not to be taken less than 10 kt

A_{wp} = ship waterplane area [m²]

CF_F = Flexural Failure Class Factor from Table 1

Where applicable, draught dependent quantities are to be determined at the waterline corresponding to the loading condition under consideration.

Figure 7 - Bow shape definition

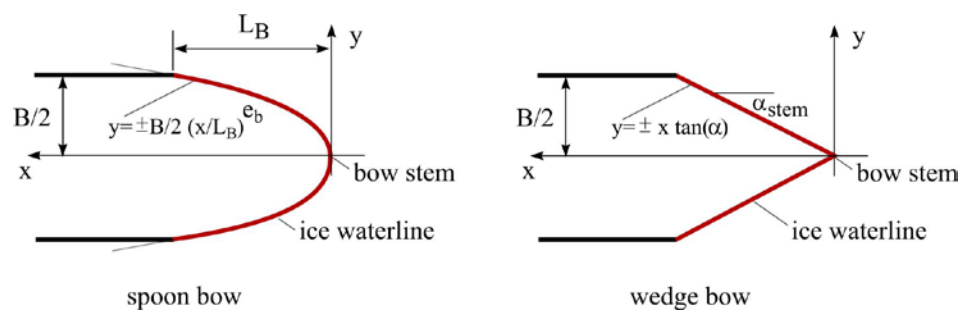

I2 (cont)

Figure 8 - Illustration of e_b effect on the bow shape for $B = 20$ and $L_B = 16$

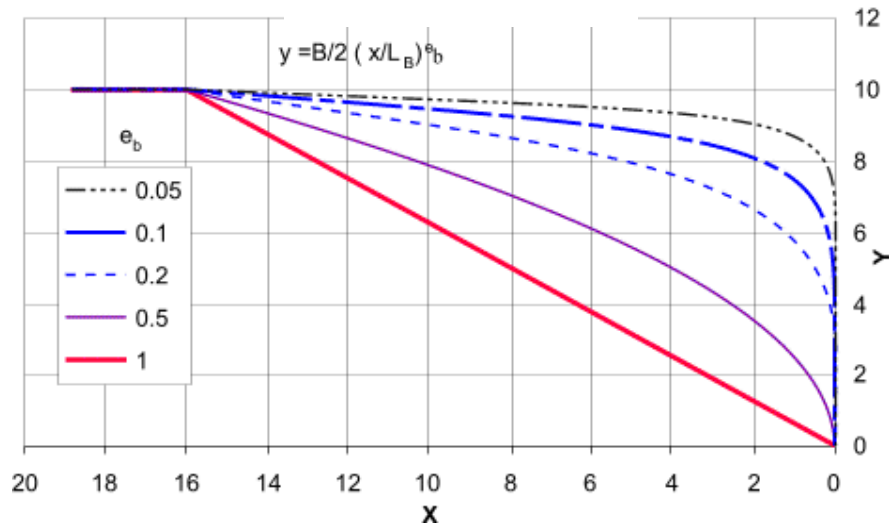

I2.13.3 Design vertical shear force

I2.13.3.1 The design vertical ice shear force, F_I , along the hull girder is to be taken as:

$$F_I = C_f \cdot F_{IB} \text{ [MN]}$$

where C_f = longitudinal distribution factor to be taken as follows:

(a) Positive shear force

$C_f = 0.0$ between the aft end of L and $0.6L$ from aft

$C_f = 1.0$ between $0.9L$ from aft and the forward end of L

(b) Negative shear force

$C_f = 0.0$ at the aft end of L

$C_f = -0.5$ between $0.2L$ and $0.6L$ from aft

$C_f = 0.0$ between $0.8L$ from aft and the forward end of L

Intermediate values are to be determined by linear interpolation

I2.13.3.2 The applied vertical shear stress, τ_a , is to be determined along the hull girder in a similar manner as in UR S11.5.4.2 by substituting the design vertical ice shear force for the design vertical wave shear force.

I2.13.4 Design vertical ice bending moment

I2.13.4.1 The design vertical ice bending moment, M_I , along the hull girder is to be taken as:

$$M_I = 0.1 \cdot C_m \cdot L \cdot \sin^{-0.2}(\gamma_{\text{stem}}) \cdot F_{IB} \text{ [MNm]}$$

where L = ship length as defined in UR S2.1, but measured on the upper ice waterline [UIWL] [m]

γ_{stem} is as given in I2.13.2.1

F_{IB} = design vertical ice force at the bow [MN]

C_m = longitudinal distribution factor for design vertical ice bending moment to be taken as follows:

$C_m = 0.0$ at the aft end of L

I2 (cont)

$C_m = 1.0$ between 0.5L and 0.7L from aft

$C_m = 0.3$ at 0.95L from aft

$C_m = 0.0$ at the forward end of L

Intermediate values are to be determined by linear interpolation

Where applicable, draught dependent quantities are to be determined at the waterline corresponding to the loading condition under consideration.

I2.13.4.2 The applied vertical bending stress, σ_a , is to be determined along the hull girder in a similar manner as in UR S11.5.4.1, by substituting the design vertical ice bending moment for the design vertical wave bending moment. The ship still water bending moment is to be taken as the maximum sagging moment.

I2.13.5 Longitudinal strength criteria

I2.13.5.1 The strength criteria provided in Table 9 are to be satisfied. The design stress is not to exceed the permissible stress.

Table 9 - Longitudinal strength criteria

Failure mode	Applied stress	Permissible stress when $\sigma_y / \sigma_u \leq 0.7$	Permissible stress when $\sigma_y / \sigma_u > 0.7$
Tension	σ_a	$\eta \cdot \sigma_y$	$\eta \cdot 0.41 (\sigma_u + \sigma_y)$
Shear	τ_a	$\eta \cdot \sigma_y / (3)^{0.5}$	$\eta \cdot 0.41 (\sigma_u + \sigma_y) / (3)^{0.5}$
Buckling	σ_a	σ_c for plating and for web plating of stiffeners $\sigma_c / 1.1$ for stiffeners	
	τ_a	τ_c	

where σ_a = applied vertical bending stress [N/mm²]

τ_a = applied vertical shear stress [N/mm²]

σ_y = minimum upper yield stress of the material [N/mm²]

σ_u = ultimate tensile strength of material [N/mm²]

σ_c = critical buckling stress in compression, according to UR S11.5 [N/mm²]

τ_c = critical buckling stress in shear, according to UR S11.5 [N/mm²]

$\eta = 0.8$

$\eta = 0.6$ for ships which are assigned the additional notation "Icebreaker"

I2.14 Stem and stern frames

I2.14.1 The stem and stern frame are to be designed according to the requirements of the Classification Society. For PC6/PC7 ships requiring IAS/IA equivalency, the stem and stern requirements of the Finnish-Swedish Ice Class Rules may need to be additionally considered.

I2.15 Appendages

I2.15.1 All appendages are to be designed to withstand forces appropriate for the location of their attachment to the hull structure or their position within a hull area.

I2.15.2 Load definition and response criteria are to be determined by the Classification Society.

I2
(cont)**I2.16 Local details**

I2.16.1 For the purpose of transferring ice-induced loads to supporting structure (bending moments and shear forces), local design details are to comply with the requirements of the Classification Society.

I2.16.2 The loads carried by a member in way of cut-outs are not to cause instability. Where necessary, the structure is to be stiffened.

I2.17 Direct calculations

I2.17.1 Direct calculations are not to be utilised as an alternative to the analytical procedures prescribed for the shell plating and local frame requirements given in I2.4, I2.6, and I2.7.

I2.17.2 Direct calculations are to be used for load carrying stringers and web frames forming part of a grillage system.

I2.17.3 Where direct calculation is used to check the strength of structural systems, the load patch specified in I2.3 is to be applied, without being combined with any other loads. The load patch is to be applied at locations where the capacity of these members under the combined effects of bending and shear is minimised. Special attention is to be paid to the shear capacity in way of lightening holes and cut-outs in way of intersecting members.

I2.17.4 The strength evaluation of web frames and stringers may be performed based on linear or non-linear analysis. Recognized structural idealisation and calculation methods are to be applied, but the detailed requirements are to be specified by the Classification Society. In the strength evaluation, the guidance given in I2.17.5 and I2.17.6 may generally be considered.

I2.17.5 If the structure is evaluated based on linear calculation methods, the following are to be considered:

- (1) Web plates and flange elements in compression and shear to fulfil relevant buckling criteria as specified by the Classification Society
- (2) Nominal shear stresses in member web plates to be less than $\sigma_y / \sqrt{3}$
- (3) Nominal von Mises stresses in member flanges to be less than $1.15 \sigma_y$

I2.17.6 If the structure is evaluated based on non-linear calculation methods, the following are to be considered:

- (1) The analysis is to reliably capture buckling and plastic deformation of the structure
- (2) The acceptance criteria are to ensure a suitable margin against fracture and major buckling and yielding causing significant loss of stiffness
- (3) Permanent lateral and out-of plane deformation of considered member are to be minor relative to the relevant structural dimensions
- (4) Detailed acceptance criteria to be decided by the Classification Society

I2**(cont)****I2.18 Welding**

I2.18.1 All welding within ice-strengthened areas is to be of the double continuous type.

I2.18.2 Continuity of strength is to be ensured at all structural connections.

End of Document

I3 Machinery Requirements for Polar Class Ships

(August
2006)
(Rev.1
Jan
2007)
(Corr.1
Oct
2007)

I3.1 Application *

The contents of this Chapter apply to main propulsion, steering gear, emergency and essential auxiliary systems essential for the safety of the ship and the survivability of the crew.

I3.2

I3.2.1 Drawings and particulars to be submitted

I3.2.1.1 Details of the environmental conditions and the required ice class for the machinery, if different from ship's ice class.

I3.2.1.2 Detailed drawings of the main propulsion machinery. Description of the main propulsion, steering, emergency and essential auxiliaries are to include operational limitations. Information on essential main propulsion load control functions.

I3.2.1.3 Description detailing how main, emergency and auxiliary systems are located and protected to prevent problems from freezing, ice and snow and evidence of their capability to operate in intended environmental conditions.

I3.2.1.4 Calculations and documentation indicating compliance with the requirements of this chapter.

I3.2.2 System Design

I3.2.2.1 Machinery and supporting auxiliary systems shall be designed, constructed and maintained to comply with the requirements of "periodically unmanned machinery spaces" with respect to fire safety. Any automation plant (i.e. control, alarm, safety and indication systems) for essential systems installed is to be maintained to the same standard.

I3.2.2.2 Systems, subject to damage by freezing, shall be drainable.

I3.2.2.3 Single screw vessels classed PC1 to PC5 inclusive shall have means provided to ensure sufficient vessel operation in the case of propeller damage including CP-mechanism.

* Note:

1. This UR is to be uniformly applied by IACS Societies on ships contracted for construction on and after 1 March 2008.
2. The "contracted for construction" date means the date on which the contract to build the vessel is signed between the prospective owner and the shipbuilder. For further details regarding the date of "contract for construction", refer to IACS Procedural Requirement (PR) No. 29.

I3

(cont)

I3.3 Materials

I3.3.1 Materials exposed to sea water

Materials exposed to sea water, such as propeller blades, propeller hub and blade bolts shall have an elongation not less than 15% on a test piece the length of which is five times the diameter.

Charpy V impact test shall be carried out for other than bronze and austenitic steel materials. Test pieces taken from the propeller castings shall be representative of the thickest section of the blade. An average impact energy value of 20 J taken from three Charpy V tests is to be obtained at minus 10 °C.

I3.3.2 Materials exposed to sea water temperature

Materials exposed to sea water temperature shall be of steel or other approved ductile material.

An average impact energy value of 20 J taken from three tests is to be obtained at minus 10 °C.

I3.3.3 Material exposed to low air temperature

Materials of essential components exposed to low air temperature shall be of steel or other approved ductile material.

An average impact energy value of 20 J taken from three Charpy V tests is to be obtained at 10 °C below the lowest design temperature.

I3.4 Ice Interaction Load

I3.4.1 Propeller Ice Interaction

These Rules cover open and ducted type propellers situated at the stern of a vessel having controllable pitch or fixed pitch blades. Ice loads on bow propellers and pulling type propellers shall receive special consideration. The given loads are expected, single occurrence, maximum values for the whole ships service life for normal operational conditions. These loads do not cover off-design operational conditions, for example when a stopped propeller is dragged through ice. These Rules apply also for azimuthing (geared and podded) thrusters considering loads due to propeller ice interaction. However, ice loads due to ice impacts on the body of azimuthing thrusters are not covered by I3.

The loads given in section I3.4 are total loads (unless otherwise stated) during ice interaction and are to be applied separately (unless otherwise stated) and are intended for component strength calculations only. The different loads given here are to be applied separately.

F_b is a force bending a propeller blade backwards when the propeller mills an ice block while rotating ahead. F_f is a force bending a propeller blade forwards when a propeller interacts with an ice block while rotating ahead.

13

(cont)

13.4.2 Ice Class Factors

The Table below lists the design ice thickness and ice strength index to be used for estimation of the propeller ice loads.

Ice Class	H_{ice} [m]	S_{ice} [-]	S_{qice} [-]
PC1	4.0	1.2	1.15
PC2	3.5	1.1	1.15
PC3	3.0	1.1	1.15
PC4	2.5	1.1	1.15
PC5	2.0	1.1	1.15
PC6	1.75	1	1
PC7	1.5	1	1

H_{ice} Ice thickness for machinery strength design

S_{ice} Ice strength index for blade ice force

S_{qice} Ice strength index for blade ice torque

13.4.3 Design Ice Loads for Open Propeller

13.4.3.1 Maximum Backward Blade Force, F_b

when $D < D_{limit}$,

$$F_b = -27 S_{ice} [nD]^{0.7} \left[\frac{EAR}{Z} \right]^{0.3} [D] \quad \text{kN} \quad \text{[Equation 1]}$$

when $D \geq D_{limit}$,

$$F_b = -23 S_{ice} [nD]^{0.7} \left[\frac{EAR}{Z} \right]^{0.3} [H_{ice}]^{1.4} [D] \quad \text{kN} \quad \text{[Equation 2]}$$

where $D_{limit} = 0.85 * (H_{ice})^{1.4}$

n is the nominal rotational speed (at MCR free running condition) for CP-propeller and 85% of the nominal rotational speed (at MCR free running condition) for a FP-propeller (regardless driving engine type).

F_b is to be applied as a uniform pressure distribution to an area on the back (suction) side of the blade for the following load cases:

- Load case 1: from 0.6R to the tip and from the blade leading edge to a value of 0.2 chord length.
- Load case 2: a load equal to 50% of the F_b is to be applied on the propeller tip area outside of 0.9R.

I3 (cont)

c) Load case 5: for reversible propellers a load equal to 60% of the F_b is to be applied from 0.6R to the tip and from the blade trailing edge to a value of 0.2 chord length.

See load cases 1, 2 and 5 in Table 1 of Appendix.

I3.4.3.2 Maximum Forward Blade Force, F_f

when $D < D_{limit}$

$$F_f = 250 \left[\frac{EAR}{Z} \right] [D]^2 \quad \text{kN} \quad \text{[Equation 3]}$$

when $D \geq D_{limit}$

$$F_f = 500 \left(\frac{1}{1 - \frac{d}{D}} \right) H_{ice} \left[\frac{EAR}{Z} \right] [D] \quad \text{kN} \quad \text{[Equation 4]}$$

where

$$D_{limit} = \left(\frac{2}{1 - \frac{d}{D}} \right) H_{ice} \quad \text{[Equation 5]}$$

d = propeller hub diameter [m]

D = propeller diameter [m]

EAR = expanded blade area ratio

Z = number of propeller blades

F_f is to be applied as a uniform pressure distribution to an area on the face (pressure) side of the blade for the following loads cases:

- Load case 3: from 0.6R to the tip and from the blade leading edge to a value of 0.2 chord length.
- Load case 4: a load equal to 50% of the F_f is to be applied on the propeller tip area outside of 0.9R.
- Load case 5: for reversible propellers a load equal to 60% F_f is to be applied from 0.6R to the tip and from the blade trailing edge to a value of 0.2 chord length.

See load cases 3, 4 and 5 in Table 1 of Appendix.

I3.4.3.3 Maximum Blade Spindle Torque, Q_{smax}

Spindle torque Q_{smax} around the spindle axis of the blade fitting shall be calculated both for the load cases described in I3.4.3.1 & I3.4.3.2 for F_b F_f . If these spindle torque values are less than the default value given below, the default minimum value shall be used.

$$\text{Default Value: } Q_{smax} = 0.25 \cdot F \cdot c_{0.7} \quad \text{[kNm]} \quad \text{[Equation 6]}$$

I3
(cont)

where

$c_{0.7}$ = length of the blade chord at 0.7R radius [m]

F is either F_b or F_f which ever has the greater absolute value.

I3.4.3.4 Maximum Propeller Ice Torque applied to the propeller

When $D < D_{limit}$

$$Q_{max} = 105 \times (1 - d / D) \times S_{qice} \times (P_{0.7} / D)^{0.16} \times (t_{0.7} / D)^{0.6} \times (nD)^{0.17} \times D^3 \quad \text{kNm} \quad \text{[Equation 7]}$$

When $D \geq D_{limit}$

$$Q_{max} = 202 \times (1 - d / D) \times S_{qice} \times H_{ice}^{1.1} \times (P_{0.7} / D)^{0.16} \times (t_{0.7} / D)^{0.6} \times (nD)^{0.17} \times D^{1.9} \quad \text{kNm} \quad \text{[Equation 8]}$$

where

$D_{limit} = 1.81 H_{ice}$

S_{qice} = Ice strength index for blade ice torque

$P_{0.7}$ = propeller pitch at 0.7 R [m]

$t_{0.7}$ = max thickness at 0.7 radius

n is the rotational propeller speed, [rps], at bollard condition. If not known, n is to be taken as follows:

Propeller type	n
CP propellers	n_n
FP propellers driven by turbine or electric motor	n_n
FP propellers driven by diesel engine	$0.85 n_n$

Where n_n is the nominal rotational speed at MCR, free running condition.

For CP propellers, propeller pitch, $P_{0.7}$ shall correspond to MCR in bollard condition. If not known, $P_{0.7}$ is to be taken as $0.7 \cdot P_{0.7n}$, where $P_{0.7n}$ is propeller pitch at MCR free running condition.

I3.4.3.5 Maximum Propeller Ice Thrust applied to the shaft

$$T_f = 1.1 \cdot F_f \quad \text{kN} \quad \text{[Equation 9]}$$

$$T_b = 1.1 \cdot F_b \quad \text{kN} \quad \text{[Equation 10]}$$

I3.4.4 Design Ice Loads for Ducted Propeller

I3.4.4.1 Maximum Backward Blade Force, F_b

when $D < D_{limit}$

$$F_b = -9.5 S_{ice} \left[\frac{EAR}{Z} \right]^{0.3} [nD]^{0.7} D^2 \quad \text{[Equation 11]}$$

I3 (cont)

when $D \geq D_{limit}$

$$F_b = -66 S_{ice} \left[\frac{EAR}{Z} \right]^{0.3} [nD]^{0.7} D^{0.6} [H_{ice}]^4 \quad \text{[Equation 12]}$$

where $D_{limit} = 4 H_{ice}$

n shall be taken as in I3.4.3.1

F_b is to be applied as a uniform pressure distribution to an area on the back side for the following load cases (see Table 2 of Appendix):

- a) Load case 1: On the back of the blade from 0.6R to the tip and from the blade leading edge to a value of 0.2 chord length.
- b) Load case 5: For reversible rotation propellers a load equal to 60% of F_b is applied on the blade face from 0.6R to the tip and from the blade trailing edge to a value of 0.2 chord length.

I3.4.4.2 Maximum Forward Blade Force, F_f

when $D \leq D_{limit}$

$$F_f = 250 \cdot \left[\frac{EAR}{Z} \right] \cdot D^2 \quad \text{[kN]} \quad \text{[Equation 13]}$$

When $D > D_{limit}$

$$F_f = 500 \cdot \left[\frac{EAR}{Z} \right] \cdot D \cdot \frac{1}{\left(1 - \frac{d}{D}\right)} \cdot H_{ice} \quad \text{[kN]} \quad \text{[Equation 14]}$$

$$\text{where } D_{limit} = \frac{2}{\left(1 - \frac{d}{D}\right)} \cdot H_{ice} \quad \text{[m]} \quad \text{[Equation 15]}$$

F_f is to be applied as a uniform pressure distribution to an area on the face (pressure) side for the following load case (see Table 2 Appendix):

- a) Load case 3: On the blade face from 0.6R to the tip and from the blade leading edge to a value of 0.5 chord length.
- b) Load case 5: A load equal to 60% F_f is to be applied from 0.6R to the tip and from the blade leading edge to a value of 0.2 chord length.

I3.4.4.3 Maximum Propeller Ice Torque applied to the propeller

Q_{max} is the maximum torque on a propeller due to ice-propeller interaction.

13 (cont)

$$Q_{max} = 74 \cdot \left[1 - \frac{d}{D}\right] \cdot \left[\frac{P_{0.7}}{D}\right]^{0.16} \cdot \left[\frac{t_{0.7}}{D}\right]^{0.6} \cdot (nD)^{0.17} \cdot S_{q_{ice}} \cdot D^3 \text{ [kNm]} \quad \text{[Equation 16]}$$

when $D \leq D_{limit}$

$$Q_{max} = 141 \cdot \left[1 - \frac{d}{D}\right] \cdot \left[\frac{P_{0.7}}{D}\right]^{0.16} \cdot \left[\frac{t_{0.7}}{D}\right]^{0.6} \cdot (nD)^{0.17} \cdot S_{q_{ice}} \cdot D^{1.9} \cdot H_{ice}^{1.1} \text{ [kNm]} \quad \text{[Equation 17]}$$

when $D > D_{limit}$

where $D_{limit} = 1.8 \cdot H_{ice}$ [m]

n is the rotational propeller speed [rps] at bollard condition. If not known, n is to be taken as follows:

	n
CP propellers	n_n
FP propellers driven by turbine or electric motor	n_n
FP propellers driven by diesel engine	$0.85 n_n$

Where n_n is the nominal rotational speed at MCR, free running condition.

For CP propellers, propeller pitch, $P_{0.7}$ shall correspond to MCR in bollard condition. If not known, $P_{0.7}$ is to be taken as $0.7 \cdot P_{0.7n}$, where $P_{0.7n}$ is propeller pitch at MCR free running condition.

13.4.4.4 Maximum Blade Spindle Torque for CP-mechanism Design, Q_{smax}

Spindle torque Q_{smax} around the spindle axis of the blade fitting shall be calculated for the load case described in 3.4.1. If these spindle torque values are less than the default value given below, the default value shall be used.

Default Value: $Q_{smax} = 0.25 \cdot F \cdot c_{0.7}$ [kNm] [Equation 18]

Where $c_{0.7}$ the length of the blade section at 0.7R radius and F is either F_b or F_f which ever has the greater absolute value.

13.4.4.5 Maximum Propeller Ice Thrust (applied to the shaft at the location of the propeller)

$$T_f = 1.1 \cdot F_f \quad \text{[Equation 19]}$$

$$T_b = 1.1 \cdot F_b \quad \text{[Equation 20]}$$

13.4.5 Reserved

I3**(cont)**

I3.4.6 Design Loads on Propulsion Line

I3.4.6.1 Torque

The propeller ice torque excitation for shaft line dynamic analysis shall be described by a sequence of blade impacts which are of half sine shape and occur at the blade. The torque due to a single blade ice impact as a function of the propeller rotation angle is then

$$Q(\varphi) = C_q * Q_{\max} * \sin(\varphi(180 / \alpha_i)) \quad \text{when } \varphi = 0 \dots \alpha_i \quad \text{[Equation 21]}$$

$$Q(\varphi) = 0 \quad \text{when } \varphi = \alpha_i \dots 360$$

where C_q and α_i parameters are given in table below.

Torque excitation	Propeller-ice interaction	C_q	α_i
Case 1	Single ice block	0.5	45
Case 2	Single ice block	0.75	90
Case 3	Single ice block	1.0	135
Case 4	Two ice blocks with 45 degree phase in rotation angle	0.5	45

The total ice torque is obtained by summing the torque of single blades taking into account the phase shift 360deg./Z . The number of propeller revolutions during a milling sequence shall be obtained with the formula:

$$N_Q = 2 \cdot H_{ice} \quad \text{[Equation 22]}$$

The number of impacts is $Z \cdot N_Q$.

See Figure 1 in Appendix.

Milling torque sequence duration is not valid for pulling bow propellers, which are subject to special consideration.

The response torque at any shaft component shall be analysed considering excitation torque Q_{\square} at the propeller, actual engine torque Q_e and mass elastic system.

Q_e = actual maximum engine torque at considered speed

Design torque along propeller shaft line

The design torque (Q_r) of the shaft component shall be determined by means of torsional vibration analysis of the propulsion line. Calculations have to be carried out for all excitation cases given above and the response has to be applied on top of the mean hydrodynamic torque in bollard condition at considered propeller rotational speed.

I3.4.6.2 Maximum Response Thrust

Maximum thrust along the propeller shaft line is to be calculated with the formulae below. The factors 2.2 and 1.5 take into account the dynamic magnification due to axial vibration. Alternatively the propeller thrust magnification factor may be calculated by dynamic analysis.

$$\text{Maximum Shaft Thrust Forwards: } T_r = T_n + 2.2 \times T_f \quad \text{[kN]} \quad \text{[Equation 24]}$$

$$\text{Maximum Shaft Thrust Backwards: } T_r = 1.5 \times T_b \quad \text{[kN]} \quad \text{[Equation 25]}$$

I3 (cont)

T_n = propeller bollard thrust [kN]
 T_f = maximum forward propeller ice thrust [kN]

If hydrodynamic bollard thrust, T_n is not known, T_n is to be taken as follows:

Propeller type	T_n
CP propellers (open)	1.25 T
CP propellers (ducted)	1.1 T
FP propellers driven by turbine or electric motor	T
FP propellers driven by diesel engine (open)	0.85 T
FP propellers driven by diesel engine (ducted)	0.75 T

T = nominal propeller thrust at MCR at free running open water conditions

I3.4.6.3 Blade Failure Load for both Open and Nozzle Propeller

The force is acting at 0.8R in the weakest direction of the blade and at a spindle arm of 2/3 of the distance of axis of blade rotation of leading and trailing edge which ever is the greatest.

The blade failure load is:

$$F_{ex} = \frac{0.3 \cdot c \cdot t^2 \cdot \sigma_{ref}}{0.8 \cdot D - 2 \cdot r} 10^3 \quad [\text{kN}] \quad [\text{Equation 26}]$$

$$\text{where } \sigma_{ref} = 0.6 \cdot \sigma_{0.2} + 0.4 \cdot \sigma_u$$

Where σ_u and $\sigma_{0.2}$ are representative values for the blade material.

c , t and r are respectively the actual chord length, thickness and radius of the cylindrical root section of the blade at the weakest section outside root fillet, and typically will be at the termination of the fillet into the blade profile.

I3.5 Design

I3.5.1 Design Principle

The strength of the propulsion line shall be designed

- for maximum loads in I3.4;
- such that the plastic bending of a propeller blade shall not cause damages in other propulsion line components;
- with sufficient fatigue strength.

I3.5.2 Azimuthing Main Propulsors

In addition to the above requirements special consideration shall be given to the loading cases which are extraordinary for propulsion units when compared with conventional

I3 (cont)

propellers. Estimation of the loading cases must reflect the operational realities of the ship and the thrusters. In this respect, for example, the loads caused by impacts of ice blocks on the propeller hub of a pulling propeller must be considered. Also loads due to thrusters operating in an oblique angle to the flow must be considered. The steering mechanism, the fitting of the unit and the body of the thruster shall be designed to withstand the loss of a blade without damage. The plastic bending of a blade shall be considered in the propeller blade position, which causes the maximum load on the studied component.

Azimuth thrusters shall also be designed for estimated loads due to thruster body / ice interaction as per I2.15

I3.5.3 Blade Design

I3.5.3.1 Maximum Blade Stresses

Blade stresses are to be calculated using the backward and forward loads given in section 4.3 & 4.4. The stresses shall be calculated with recognised and well documented FE-analysis or other acceptable alternative method. The stresses on the blade shall not exceed the allowable stresses σ_{all} for the blade material given below.

Calculated blade stress for maximum ice load shall comply with the following:

$$\sigma_{calc} < \sigma_{all} = \sigma_{ref} / S$$

$$S = 1.5$$

σ_{ref} = reference stress, defined as:

$$\sigma_{ref} = 0.7 \cdot \sigma_u \quad \text{or} \quad \text{[Equation 27]}$$

$$\sigma_{ref} = 0.6 \cdot \sigma_{0.2} + 0.4 \cdot \sigma_u \quad \text{whichever is less} \quad \text{[Equation 28]}$$

Where σ_u and $\sigma_{0.2}$ are representative values for the blade material.

I3.5.3.2 Blade Edge Thickness

The blade edge thicknesses t_{ed} and tip thickness t_{tip} are to be greater than t_{edge} given by the following formula:

$$t_{edge} \geq x S S_{ice} \sqrt{\frac{3 P_{ice}}{\sigma_{ref}}} \quad \text{[Equation 29]}$$

x = distance from the blade edge measured along the cylindrical sections from the edge and shall be 2.5% of chord length, however not to be taken greater than 45 mm. In the tip area (above 0.975R radius) x shall be taken as 2.5% of 0.975R section length and is to be measured perpendicularly to the edge, however not to be taken greater than 45 mm.

S = safety factor
 = 2.5 for trailing edges
 = 3.5 for leading edges
 = 5 for tip

S_{ice} = according to Section I3.4.2

I3

(cont)

p_{ice} = ice pressure
= 16 Mpa for leading edge and tip thickness

$_ref$ = according 5.3.1

The requirement for edge thickness has to be applied for leading edge and in case of reversible rotation open propellers also for trailing edge. Tip thickness refers to the maximum measured thickness in the tip area above 0.975R radius. The edge thickness in the area between position of maximum tip thickness and edge thickness at 0.975 radius has to be interpolated between edge and tip thickness value and smoothly distributed.

I3.5.3.3 to I3.5.4.2 *Reserved*

I3.5.5 *Reserved*

I3.5.6 Prime Movers

I3.5.6.1 The Main engine is to be capable of being started and running the propeller with the CP in full pitch.

I3.5.6.2 Provisions shall be made for heating arrangements to ensure ready starting of the cold emergency power units at an ambient temperature applicable to the Polar class of the ship.

I3.5.6.3 Emergency power units shall be equipped with starting devices with a stored energy capability of at least three consecutive starts at the design temperature in I3.5.6.2 above. The source of stored energy shall be protected to preclude critical depletion by the automatic starting system, unless a second independent means of starting is provided. A second source of energy shall be provided for an additional three starts within 30 min., unless manual starting can be demonstrated to be effective.

I3.6 Machinery fastening loading accelerations

I3.6.1 Essential equipment and main propulsion machinery supports shall be suitable for the accelerations as indicated in as follows. Accelerations are to be considered acting independently.

I3.6.2 Longitudinal Impact Accelerations, a_l

Maximum longitudinal impact acceleration at any point along the hull girder

$$= (F_{IB}/\Delta) \{ [1.1 \tan(\gamma + \phi)] + [7 \frac{H}{L}] \} \quad [m/s^2] \quad \text{[Equation 31]}$$

I3.6.3 Vertical acceleration, a_v

Combined vertical impact acceleration at any point along the hull girder

$$= 2.5 (F_{IB}/\Delta) F_x \quad [m/s^2] \quad \text{[Equation 32]}$$

I3 (cont)

$F_x = 1.3$ at FP
 $= 0.2$ at midships
 $= 0.4$ at AP
 $= 1.3$ at AP for vessels conducting ice breaking astern
 Intermediate values to be interpolated linearly.

I3.6.4. Transverse impact acceleration, a_t

Combined transverse impact acceleration at any point along hull girder

$$= 3 F_i \frac{F_x}{\Delta} \quad [\text{m/s}^2] \quad \text{[Equation 33]}$$

$F_x = 1.5$ at FP
 $= 0.25$ at midships
 $= 0.5$ at AP
 $= 1.5$ at AP for vessels conducting ice breaking astern
 Intermediate values to be interpolated linearly.

where

- ϕ = maximum friction angle between steel and ice, normally taken as 10° [deg.]
- γ = bow stem angle at waterline [deg.]
- Δ = displacement
- L = length between perpendiculars [m]
- H = distance in meters from the waterline to the point being considered [m]

F_{IB} = vertical impact force, defined in UR I2.13.2.1

F_i = total force normal to shell plating in the bow area due to oblique ice impact, defined in UR I2.3.2.1

I3.7 Auxiliary Systems

I3.7.1 Machinery shall be protected from the harmful effects of ingestion or accumulation of ice or snow. Where continuous operation is necessary, means should be provided to purge the system of accumulated ice or snow.

I3.7.2 Means should be provided to prevent damage due to freezing, to tanks containing liquids.

I3.7.3 Vent pipes, intake and discharge pipes and associated systems shall be designed to prevent blockage due to freezing or ice and snow accumulation.

I3.8 Sea Inlets and cooling water systems

I3.8.1 Cooling water systems for machinery that are essential for the propulsion and safety of the vessel, including sea chests inlets, shall be designed for the environmental conditions applicable to the ice class.

I3
(cont)

13.8.2 At least two sea chests are to be arranged as ice boxes for class PC1 to PC5 inclusive where. The calculated volume for each of the ice boxes shall be at least 1m³ for every 750 kW of the total installed power. For PC6 and PC7 there shall be at least one ice box located preferably near centre line.

13.8.3 Ice boxes are to be designed for an effective separation of ice and venting of air.

13.8.4 Sea inlet valves are to be secured directly to the ice boxes. The valve shall be a full bore type.

13.8.5 Ice boxes and sea bays are to have vent pipes and are to have shut off valves connected direct to the shell.

13.8.6 Means are to be provided to prevent freezing of sea bays, ice boxes, ship side valves and fittings above the load waterline.

13.8.7 Efficient means are to be provided to re-circulate cooling seawater to the ice box. Total sectional area of the circulating pipes is not to be less than the area of the cooling water discharge pipe.

13.8.8 Detachable gratings or manholes are to be provided for ice boxes. Manholes are to be located above the deepest load line. Access is to be provided to the ice box from above.

13.8.9 Openings in ship sides for ice boxes are to be fitted with gratings, or holes or slots in shell plates. The net area through these openings is to be not less than 5 times the area of the inlet pipe. The diameter of holes and width of slot in shell plating is to be not less than 20 mm. Gratings of the ice boxes are to be provided with a means of clearing. Clearing pipes are to be provided with screw-down type non return valves.

13.9 Ballast tanks

13.9.1 Efficient means are to be provided to prevent freezing in fore and after peak tanks and wing tanks located above the water line and where otherwise found necessary.

13.10 Ventilation System

13.10.1 The air intakes for machinery and accommodation ventilation are to be located on both sides of the ship.

13.10.2 Accommodation and ventilation air intakes shall be provided with means of heating.

13.10.3 The temperature of inlet air provided to machinery from the air intakes shall be suitable for the safe operation of the machinery.

13.11 Reserved**13.12 Alternative Design**

13.12.1 As an alternative – a comprehensive design study may be submitted and may be requested to be validated by an agreed test programme.

APPENDIX

Table 1 Load cases for open propeller

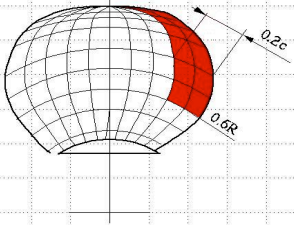
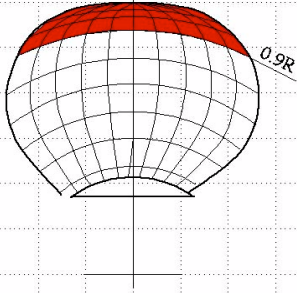
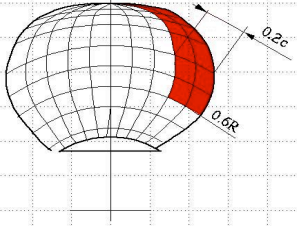
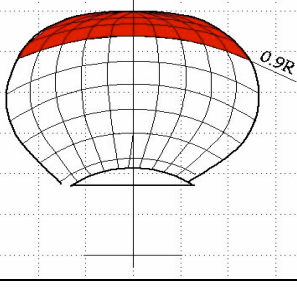
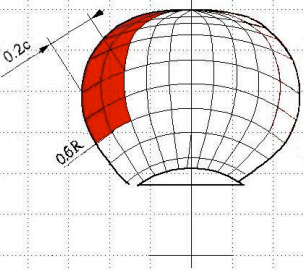
	Force	Loaded area	Right handed propeller blade seen from back
Load case 1	F_b	Uniform pressure applied on the back of the blade (suction side) to an area from $0.6R$ to the tip and from the leading edge to 0.2 times the chord length.	
Load case 2	50 % of F_b	Uniform pressure applied on the back of the blade (suction side) on the propeller tip area outside of $0.9R$ radius.	
Load case 3	F_f	Uniform pressure applied on the blade face (pressure side) to an area from $0.6R$ to the tip and from the leading edge to 0.2 times the chord length.	
Load case 4	50 % of F_f	Uniform pressure applied on propeller face (pressure side) on the propeller tip area outside of $0.9R$ radius.	
Load case 5	60 % of F_f or F_b which one is greater	Uniform pressure applied on propeller face (pressure side) to an area from $0.6R$ to the tip and from the trailing edge to 0.2 times the chord length.	 e

13

(cont)

Table 2 Load cases for ducted propeller

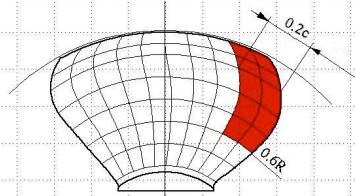
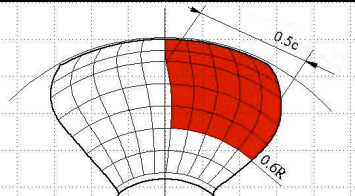
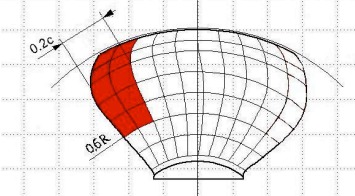
	Force	Loaded area	Right handed propeller blade seen from back
Load case 1	F_b	Uniform pressure applied on the back of the blade (suction side) to an area from $0.6R$ to the tip and from the leading edge to 0.2 times the chord length.	
Load case 3	F_f	Uniform pressure applied on the blade face (pressure side) to an area from $0.6R$ to the tip and from the leading edge to 0.5 times the chord length.	
Load case 5	60 % of F_f or F_b which one is greater	Uniform pressure applied on propeller face (pressure side) to an area from $0.6R$ to the tip and from the trailing edge to 0.2 times the chord length.	

I3

(cont)

Figure 1 The shape of the propeller ice torque excitation for 45, 90, 135 degrees single blade impact sequences and 45 degrees double blade impact sequence (two ice pieces) on a four bladed propeller.

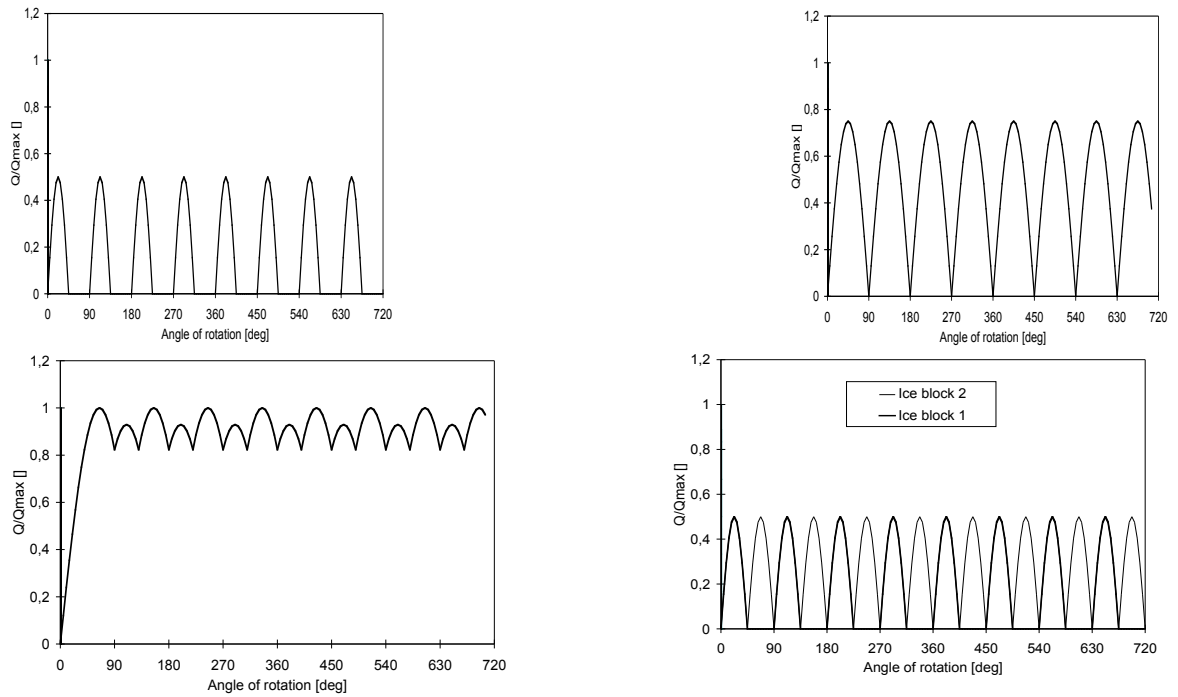

End of
Document